



SMART POND DOSING SYSTEM



**Smart Pond Dosing
System XT**
Item #40040





Smart Pond Dosing System XT

Thank you for choosing the Aquascape Smart Pond Dosing System XT. At Aquascape, we connect people to water the way nature intended. Since 1991 we've been creating and field-testing water features in order to provide you with the most reliable products and best value in the water gardening industry.



The Aquascape Smart Pond Dosing System XT is an electronically operated dispenser that accurately and consistently applies specially formulated water treatments to water features, including large scale bodies of water. Pair the control panel to the Smart Control App to control, monitor, and receive alerts on your smartphone or tablet. This instruction manual will guide you through the proper setup and recommended maintenance to ensure long-term enjoyment.

TABLE OF CONTENTS

Introduction	2
Contents	3
Safety Information	3
Specifications Chart	3
Installation	4
General Maintenance	6
Troubleshooting	6
Replacement Parts	7
Warranty	7

Contact Us

For more information about our company or products, please visit our website at aquascapeinc.com or call US (866) 877-6637 CAN (866) 766-3426.

Find us on:



facebook.com/aquascapeinc
youtube.com/aquascape4
pinterest.com/aquascapeinc
instagram.com/aquascape_inc/

Contents	
No.	Description
1.	XT Enclosure
2.	Control Panel
3.	Treatment intake with low treatment alert
4.	Low-voltage transformer
5.	External Tubing

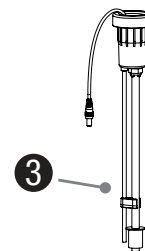
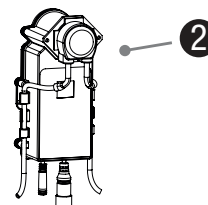
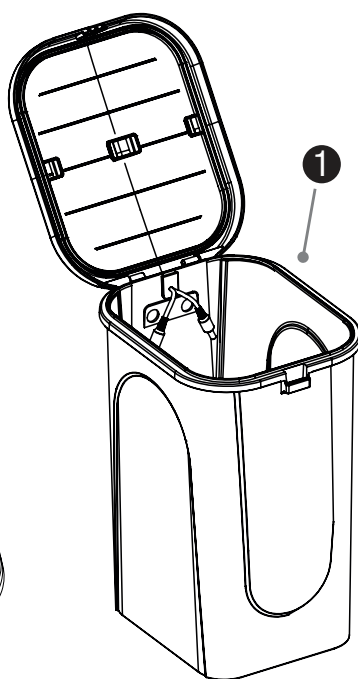
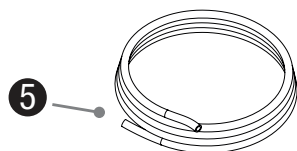
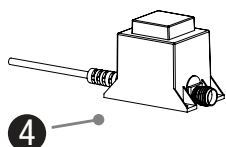

Safety Information



WARNING: To provide continued protection against risk of electric shock, connect to properly grounded, ground fault circuit interrupter (GFCI) outlets only.



PLEASE NOTE: Aquascape Smart Pond Dosing System XT water treatments have been specifically formulated to work with the Aquascape Smart Pond Dosing System XT. Using water treatments not designed for use with the system may permanently damage the unit and void the warranty.



WARNING: This product is weatherproof but is not designed to be submersed in the water.

- (B) Inspect cords for damage before using.
- (C) Do not use with extension cord.
- (D) Any wiring of this product should be performed by a qualified electrician to ensure code compliance and user safety.
- (E) To reduce risk of electrical shock, all wiring and junction connections should be made per local codes. Requirements may vary depending on usage and location.
- (F) The power cables should be protected at all times to avoid punctures, nicks or abrasions.
- (G) Never handle power cords with wet hands.
- (H) Unplug system at receptacle outlet when not in use.
- (I) Do not use power cable to lift the Smart Pond Dosing System XT.

- (A) Have a qualified electrician install a properly grounded receptacle outlet, acceptable for outdoor use when protected from direct sunlight, snow and rain. If possible, locate so that the power cord will reach the outlet without an extension cord.

Smart Pond Dosing System XT Specs

Enclosure Dimensions	Controller Wattage	Transformer Output	Transformer Wattage	Low Voltage Cable Length	External Tubing Length
10.2" x 8.5" x 13.6" 26 x 21.6 x 34.5 cm	6W	12V AC/60 Hz	12W	13 ft/3.96 m	6 ft/1.8 m

Installation

SETUP

- It is recommended to place the Smart Pond Dosing System XT as close to the water feature as possible to minimize the distance the treatment must travel.

NOTE: The XT system can be buried to conceal into the landscape (Ex. 1). Do not bury so deep that it causes issues with opening or closing the lid.

- Open the lid of the enclosure and connect the control panel by sliding downward into the tracks on the lid (Ex. 2).



Ex. 1

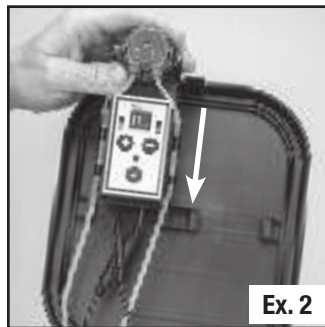

Ex. 2

- Connect the power cable to the control panel (Ex. 3).
- Connect the outlet tubing from the control panel to the closest port at the back of the enclosure (Ex. 4).



Ex. 3



Ex. 4

NOTE: Inlet and outlet tubing can be determined by referencing the indicators on the pump cartridge (Ex. 5).

- Connect the inlet tubing to the barb at the top of the intake assembly (Ex. 6). Then connect the low-treatment power cable to the control panel (Ex. 7).



Ex. 5



Ex. 6



Ex. 7

- Set the selected water treatment bottle into the system as shown. Insert the intake assembly into the top of the water treatment bottle until sealed at the top (Ex. 8).

NOTE: The XT system is designed and calibrated for use only with Aquascape Simple Solution XT water treatments, available in both half and full gallon bottles.

- Attach the discharge tubing to the proper fitting at the back of the control panel (Ex. 9).



Ex. 8



Ex. 9

- Position the opposite end of the discharge tubing where you intend to add the treatment into the water feature. Treatment can be dispensed directly into the pond or fountain or into a skimmer or pump vault (Ex. 10).

NOTE: Position discharge tubing above water level.

- Attach the transformer to the dosing system power cord using the quick-connect fitting at the end of the cable (Ex. 11).

NOTE: The unit can also be powered by an existing 12V outdoor transformer. Each Smart Controller uses 6 watts.

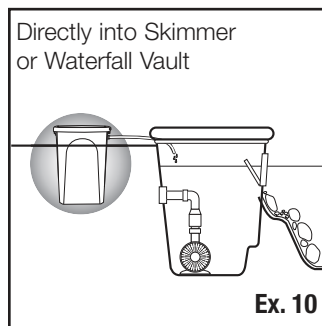

Ex. 10

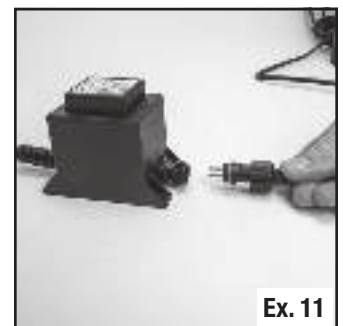

Ex. 11

- Plug the transformer into a GFCI-rated receptacle.

NOTE: the unit may run once it receives power.

- If desired, the XT system allows you to add multiple treatments simultaneously using a Controller Add-On Kit (Item #40042). This will allow you to add two half gallon treatments simultaneously (i.e. Maintain and Clear).

- The Controller Add-on Kit includes the control panel, intake assembly, and tubing. Simply slide the second control panel into the lid (Ex. 12), remove the rubber elbow attached to the secondary power cable (Ex. 13) and repeat the steps from above to complete installation.

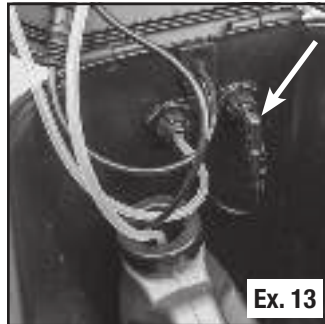
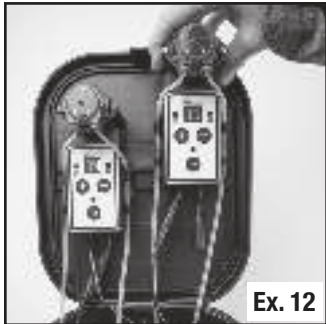

SETTINGS

- **NOTE:** If using the Smart Control App, skip down to the next section (APP PAIRING).
- The control panel will default to setting 1. To determine the setting for your water feature without using the Smart Control App, use the QR code (Ex. 14) or locate the QR code on your water treatment to access the XT setting selector.
- Once setting is determined use the + and - buttons on the control panel to set to recommended setting.



APP PAIRING

- Make controlling and monitoring the XT system easy by connecting the control panel to the Aquascape Smart Control App.
- **NOTE:** Adequate Wi-Fi Coverage is required (2.4 GHz networks supported). A strong stable network will prevent connection issues. For additional information visit aquascapeinc.com/smart-control-app.
- **NOTE:** The blinking blue light indicates the unit is in pairing mode and ready to be connected.
- Download the Aquascape Smart Control App (available on iOS or Android App Store).
- Open the app and click 'Create New Account' (Ex. 15).
- **NOTE:** If you already have an account, login with your username and password.



- Once logged in, click the three dashes in the upper, right-hand corner of the home screen (Ex. 16).
- Click 'Add New Device' (Ex. 17).

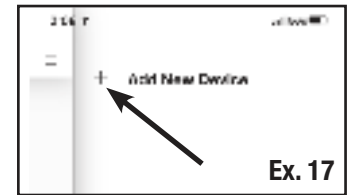
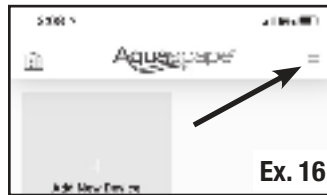

- Continue to follow on-screen instructions to complete the pairing process.
- **NOTE:** To reset the device to factory defaults, press and hold the + and - button for 5 seconds within 1 minute of connecting the controller to power then release when the LCD screen shows 88.

PRIMING PROCEDURE

- When first setting up the system or when adding a new water treatment bottle, the system should be primed to push the treatment through the output tubing.
- The priming process can be completed in the Smart Control App or manually. To manually enter the priming mode, hold the x2 button for 3 seconds until blue light above the x2 button begins to flash. The priming mode will automatically turn off after approximately three minutes, returning to normal operation. The priming mode can be exited at any time by pressing the x2 button when the treatment begins to discharge at the end of the tubing.

LOW-TREATMENT ALERT

- The system is equipped with a convenient low-treatment alert which uses an electromagnetic switch on the intake assembly to notify you when a treatment bottle is 90% empty, ensuring you can replace the treatment before it runs out.
- When 90% empty, the Low-Treatment Alert LED on the control panel will illuminate (Ex. 18).
- Pair the control panel to the Aquascape Smart Control App to receive low-treatment alerts on your smartphone or tablet (Ex. 19).

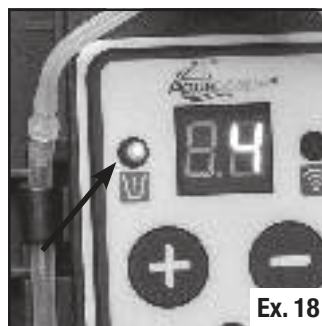

General Maintenance

- When replacing water treatments, take a few seconds to inspect and, if necessary, clean the tubing of any debris that has become trapped in the tubing.

NOTE: A soft pipe cleaner, available at most hobby stores, can be used to clean the tubing.

- The pump cartridge, located on the underside of the control panel, is a consumable part that may wear over time, reducing the accuracy of the system. It is recommended to replace the pump cartridge once each year (Item #44041) (Ex. 20).
- Do not operate at temperatures below 40°F / 4°C as doing so will void the warranty.



PLEASE NOTE: Your XT System and liquid water treatments are not designed to be operated during freezing temperatures. The unit is equipped with an internal protection thermostat that will shut off the dosing pump at temperatures below 40°F / 4°C. Remove the control panel, treatment, and intake assembly during winter freezing temperatures and store in a frost-free location

Troubleshooting

- The pump does not seem to be pumping the liquid treatment from the bottle into my feature.
 - Make sure the unit is getting power.
 - Make sure the inner tubing and discharge tubing are properly connected and not kinked.
 - Inspect and clean all tubing of water treatment residue using a pipe cleaner
 - Make sure the system is primed. To enter the priming mode, hold the x2 dosing button for 3 seconds (this may take several minutes). Refer to page 5 for more information.
 - With priming mode engaged, listen closely, as you should be able to hear the pump turning if it's working correctly.
 - If the pump is not turning when in priming mode, you may need to replace the control panel.
 - If problems persist, it may be time to replace the pump cartridge.
- Pump does not seem to be pumping accurately.
 - Replace the pump cartridge as explained in General Maintenance (Ex. 20).
- There is no power reaching the unit.
 - Make sure the ground-fault circuit interrupter (GFCI) is not tripped.
 - Check that the transformer is plugged in.
 - Try replacing the transformer; please note that the Aquascape Automatic Dosing System uses a 12V low voltage outdoor rated transformer.
- Device won't pair.
 - Make sure the outlet is receiving power.
 - Make sure the network name and password are typed in correctly.
 - Make sure you have adequate wireless coverage to connect the device.
 - Reset the device to factory default by pressing and holding the + and - button for 5 seconds within 1 minute of connecting the controller to power then release when the LCD screen shows 88.
 - Visit our website aquascapeinc.com for more device pairing videos and instruction.

Replacement Parts

Smart Pond Dosing System XT Replacement Parts	
No.	Item number/description
1.	40041 – Smart Pond Dosing System Pump Cartridge
2.	40043 – Smart Pond Dosing System Intake Assembly
3.	40044 – Smart Pond Dosing System XT Enclosure
4.	40045 – Smart Pond Dosing System XT Tubing Kit
5.	40046 – Smart Pond Dosing System XT Quick-Connect Outlets (2)
6.	40047 – Smart Pond Dosing System XT 12W Transformer
7.	40060 – Smart Pond Dosing System Control Panel

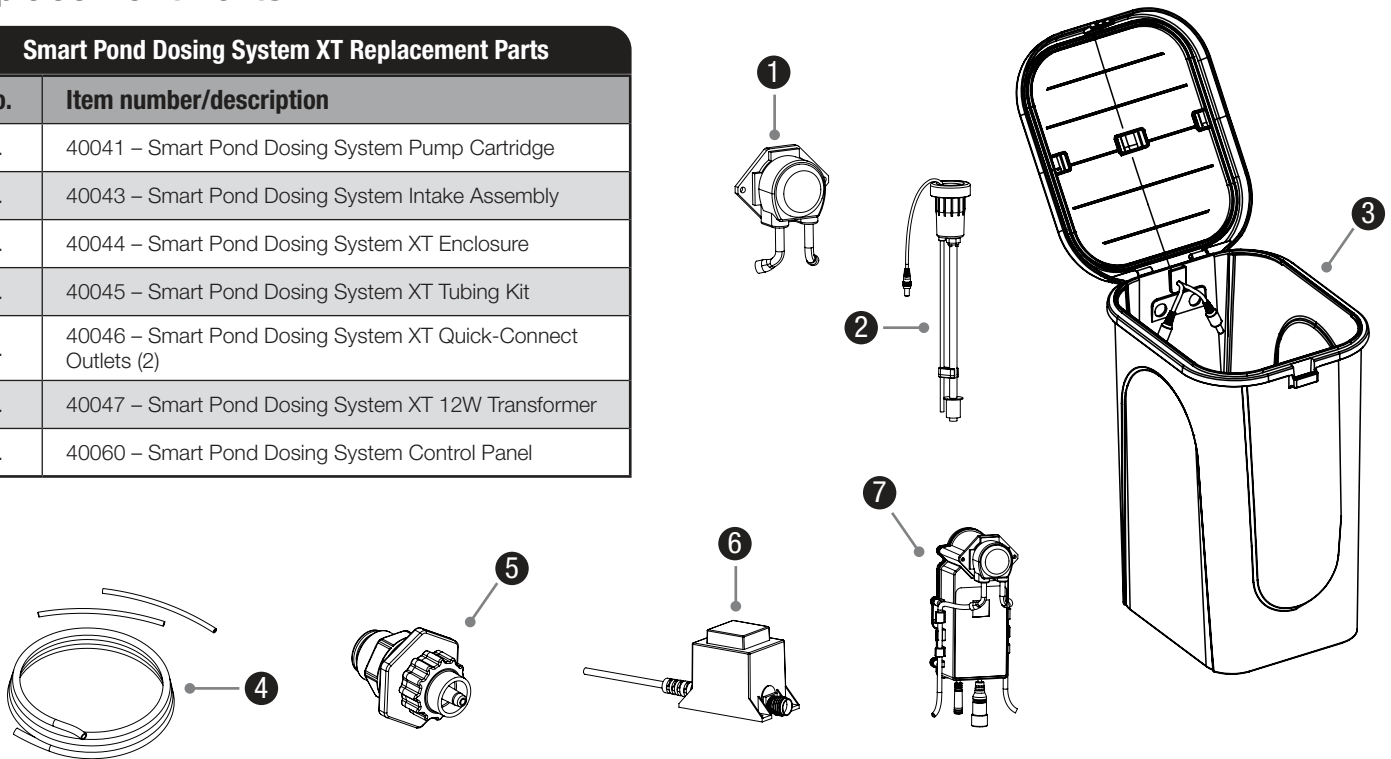

Warranty

1 YEAR WARRANTY

Aquascape warrants that the Smart Pond Dosing System XT will be free of manufacturing defects for one year from the date of purchase. Proof of purchase required. Warranty does not cover damage resulting from electrical supply problems, lighting, negligent handling, misuse or lack of reasonable maintenance or care. Warranty does not cover parts subject to normal wear, such as replacement pump cartridges. If upon Aquascape's inspection, the system shows evidence of a manufacturing defect, Aquascape's liability is limited, at Aquascape's option, to the repair of the defect, replacement of the defective product, or refund of the original purchase price. The warranty excludes costs of labor, removal of product, shipping and expenses related to the installation and re-installation of the product. All products that include plumbing (tubing, pumps, check valves) need to be properly drained and winterized otherwise warranty is null and void. No liability for loss or damage of any nature or kind, whether arising out of or from the use of the product, whether defective or not defective, is assumed by Aquascape, Inc. or its affiliates. Aquascape shall not be liable for any incidental, consequential or other damages arising under any theory of law whatsoever.

For more information about our company or products, please visit our website at aquascapeinc.com
or call us at US (866) 877-6637 CAN (866) 766-3426

©2021 Aquascape, Inc. • All Worldwide Rights Reserved